

- A DB9 **null modem cable** (or adapter) is required when you want to connect console port to a PC with terminal emulation software such as TeraTerm.
- Turn on PC, run the terminal emulation program (e.g. **TeraTerm**), and open TeraTerm COM port.

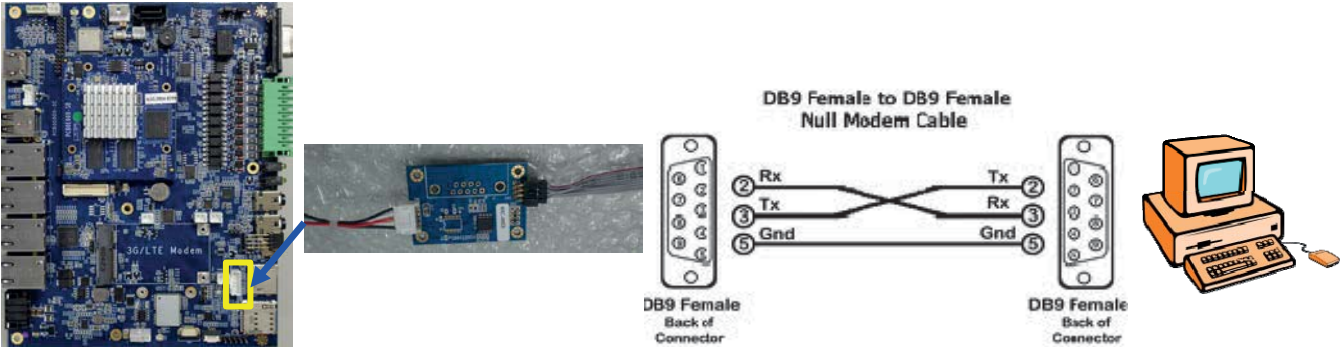

- Set COM port at **Baud Rate 115200. 8 data bits. no parity. 1 stop bit and no flow control.**
- After the above connection/setting, you will see Linux console prompt "\$" in the PC TeraTerm.

Pin Assignment: RS232 IDC Cable and Null Modem Adapter

- Console box header (CN3 on C220 board) pin assignment

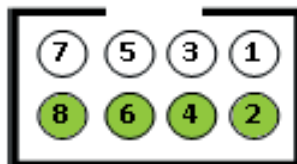

- RS232 IDC cable: pin header for DB9

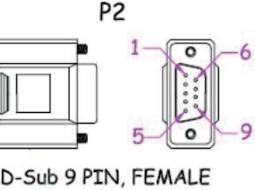
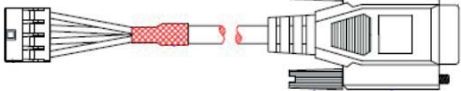
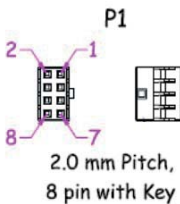

WIRE TERMINATIONS

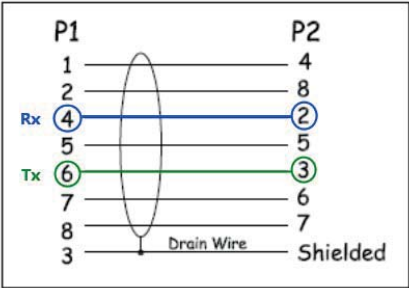

- Null modem adapter: male-to-male for DB9

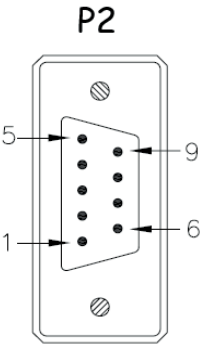
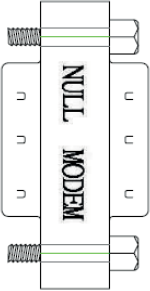
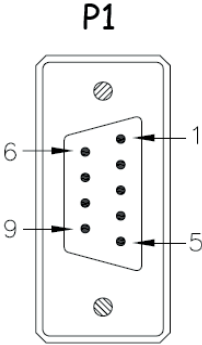

DB9 M/M ADAPTER

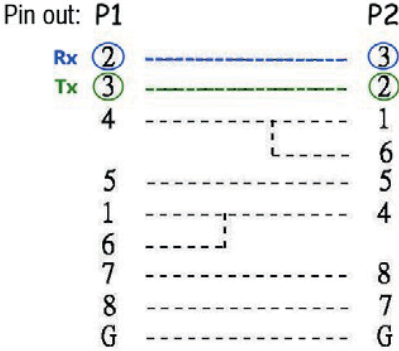

One side: NULL MODEM
The other side: MINI ADAPTER